

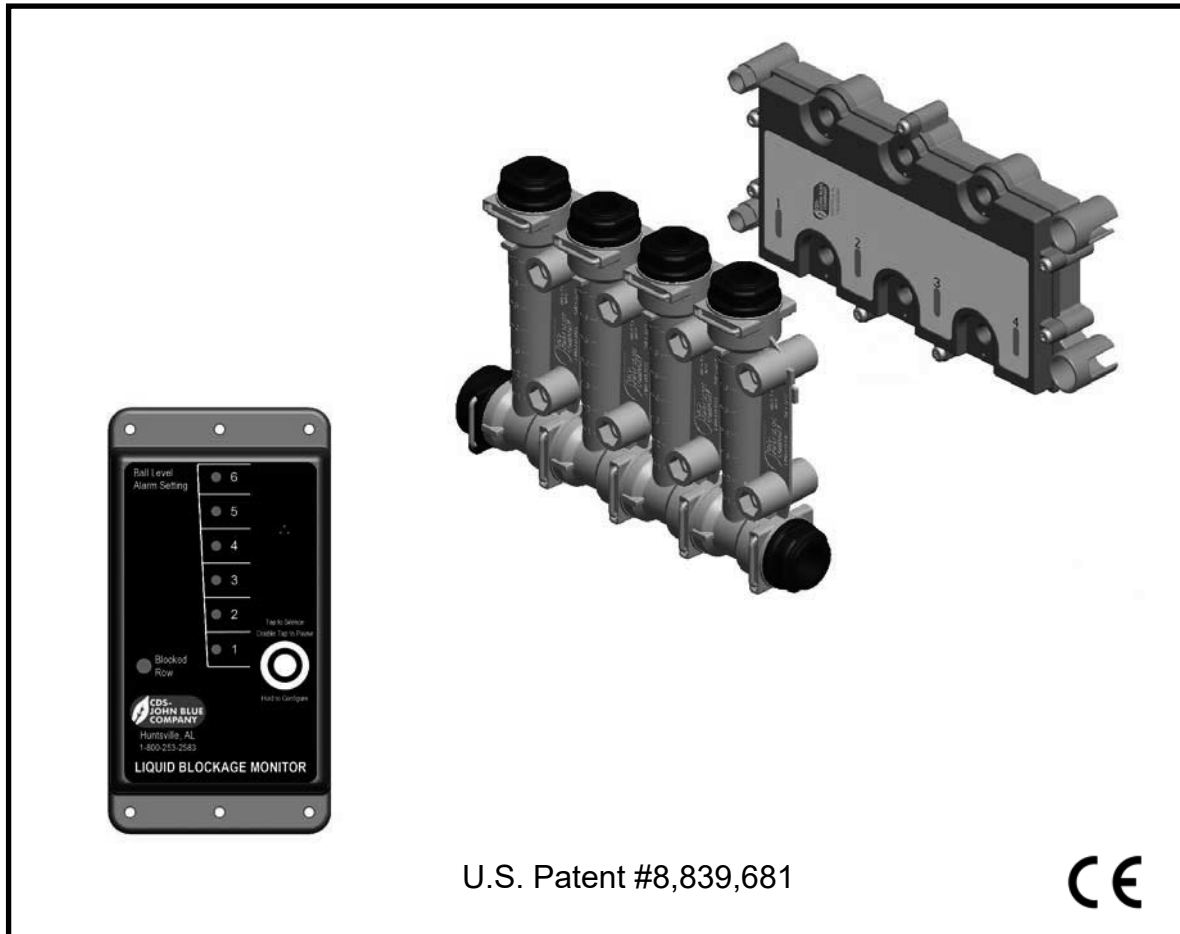

BM-08AP/PL STANDARD LIQUID BLOCKAGE MONITOR SYSTEM

PARTS AND INSTALLATION MANUAL



CDS-JOHN BLUE COMPANY

DIVISION OF ADVANCED SYSTEMS TECHNOLOGY, INC.

165 Electronics Blvd, Huntsville, AL 35824

Telephone: (256) 721-9090 - FAX: (256) 721-9091

Toll Free: 1-800-253-2583

TABLE OF CONTENTS

Safety Precautions	2
System Description	3
How to Order	4
Installation	5
Operation	7
Troubleshooting	9
Parts List	10
Warranty	12

SAFETY PRECAUTIONS

- Equipment should be operated only by responsible people.
- A careful operator is the best insurance against an accident.

WARNING: USE OF THIS PRODUCT FOR ANY PURPOSES OTHER THAN ITS ORIGINAL INTENT, ABUSE OF THE PRODUCT, AND/OR MODIFICATION TO THE ORIGINAL PRODUCT IS STRICTLY PROHIBITED BY CDS-JOHN BLUE COMPANY. CDS-JOHN BLUE COMPANY RESERVES THE RIGHT TO DENY WARRANTY OR LIABILITY CLAIMS IN ANY/ALL SITUATIONS INVOLVING MISUSE, ABUSE OR MODIFICATION.

THE ORIGINAL INTENT OF THIS PRODUCT DOES NOT INCLUDE USE WHERE THE MAXIMUM ALLOWED SPEED, PRESSURE, OR TEMPERATURE IS EXCEEDED, AND IT DOES NOT INCLUDE APPLICATIONS UTILIZING FLUIDS THAT ARE NOT COMPATIBLE WITH THE PRODUCT'S COMPONENT MATERIALS. DO NOT USE THIS PRODUCT WITH FLAMMABLE OR COMBUSTIBLE FLUIDS SUCH AS GASOLINE, KEROSENE, DIESEL, ETC..., AND DO NOT USE IN EXPLOSIVE ATMOSPHERES. FAILURE TO FOLLOW THIS NOTICE MAY RESULT IN SERIOUS INJURY AND/OR PROPERTY DAMAGE AND WILL VOID THE PRODUCT WARRANTY. IF IN DOUBT ABOUT YOUR APPLICATION, CONTACT YOUR STOCKING DEALER OR THE CDS-JOHN BLUE TECHNICAL STAFF AT 1-800-253-2583.

To The Owner

This manual has been prepared and illustrated to assist you in the maintenance of your CDS – JOHN BLUE product. Enter your serial number and the date of the purchase in the space provided below for future reference in service information or for ordering parts. Because our engineering department is constantly improving products, we reserve the right to make design and specification changes without notice.

Model Number: _____ Serial Number: _____ Purchase Date: _____

SYSTEM DESCRIPTION

The CDS-John Blue Standard Liquid Blockage Monitor System is an automatic warning system that lets the operator know when the ball (and flow) in an individual row has dropped below a selected level in a CDS-John Blue Visagage II flow monitor.

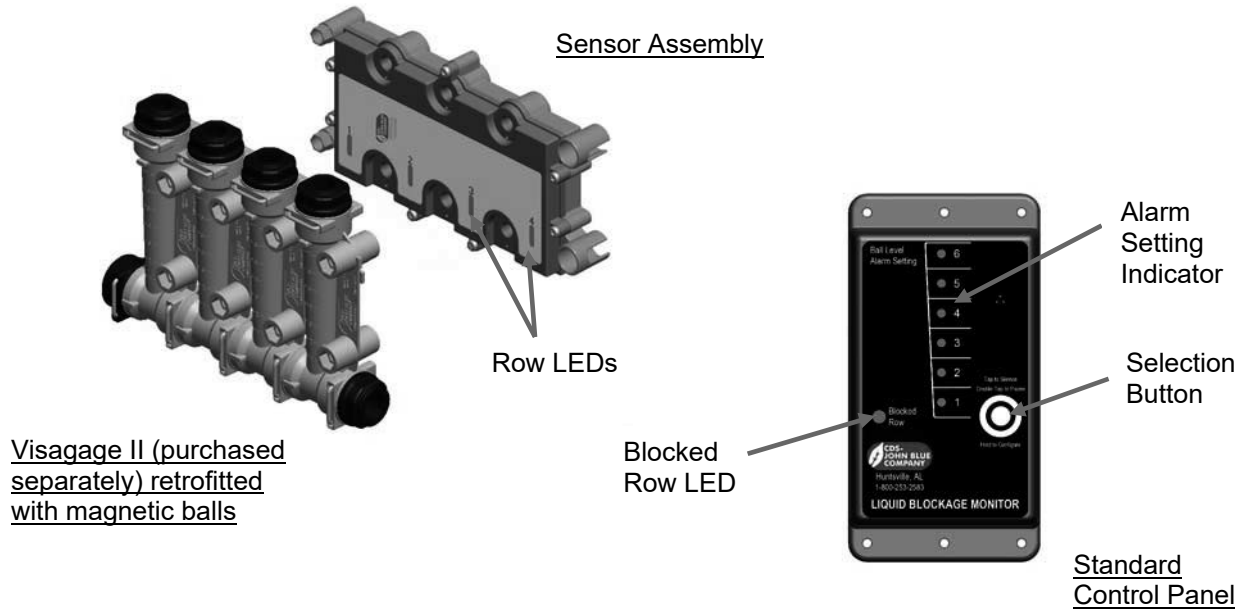

The standard system uses sensor assemblies mounted behind the Visagage flow monitors to sense where magnetic balls are floating in each row during liquid application. A control panel in the cab allows the user to select at which level on the Visagage the alarm will sound when a ball drops to or below that level.

When a low ball position has been detected, the “blocked row” LED will flash and an alarm will sound on the control panel. Additionally, each row that had a low ball will be highlighted by a flashing LED in the sensor assemblies behind the Visagage columns to help with troubleshooting the blockages. When the blockage has been corrected and the ball again goes above the alarm level, the alarm will reset automatically.

The base system is sold with enough components to monitor an 8-row system. To size it for larger machines, 4-row Sensor Expansion Kits (part #BMPT-001) are added as needed. Note that while the sensor assemblies are sized to monitor 4-rows at a time, it is ok to leave rows empty if the machine has an odd number of rows.

Two different kit numbers are available to better fit the machine type: one for applicators (BM-08AP) and another for planters (BM-08PL). The difference between them is related to where the Visagages are usually placed on the machine, which is usually wider on a planter so two more harnesses are provided in the kit. The harness lengths are sized for normal size machines, but if longer lengths are needed extension cables are available - measure the machine first.

HOW TO ORDER

Step 1: Purchase one of the Standard 8 Row Liquid Blockage Monitor Kits, BM-08AP or BM-08PL, which differ by item(s) "G". See the following:

Components included in BM-08AP & PL:

- A. Control Panel with Mount Bracket
- B. Input Harness
- C. 28ft Extension harness
- D. Tee Harness
- E. Standard Sensor Expansion Kit (qty =2)
(includes sensor, tee harness, 12 magnet balls, & hardware)
- F. Terminator Plug (qty =2)
- G. 15ft Ext. Harness (qty =2 * *Only included in BM-08PL kit*)

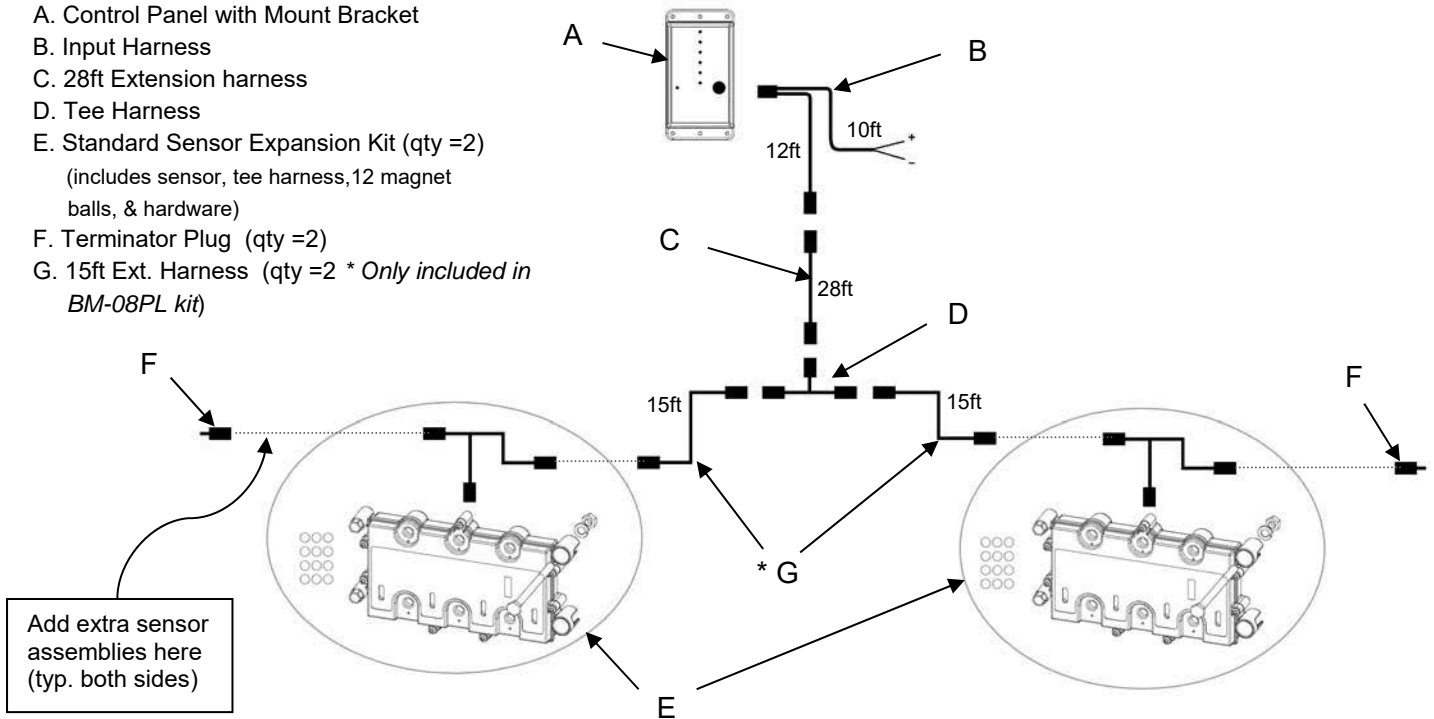

Step 2: If the harness lengths supplied are not long enough for your machine measurements, you can order more of these harnesses and add them anywhere in the circuit:

BMPT-012	28FT Extension harness
BMPT-013	15FT Extension harness
BMPT-014	7FT Extension harness

Step 3: Purchase the required number of 4-Row Sensor Expansion Kits (#BMPT-001, item "E" above) to cover the number of rows on your machine (leaving extra rows empty is ok). The location of the individual sensors does not matter, and they do not have to be evenly split from side to side.

Step 4: Order the required number of Visagage II assemblies for your machine, and at installation replace the standard balls with the appropriate magnet ball for your specific row flow rate (see page 5).

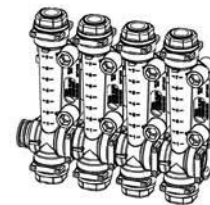

INSTALLATION

1.) Mounting the Liquid Blockage Monitor Sensors: The sensors mount behind the Visagage II columns using the provided hardware. The assembly must be mounted vertically as shown, and lengthwise it should be horizontal. Clearance must be given around the wiring connector on the back of the sensor, so a good choice for mounting bracket material would be two strips of angle or bar.

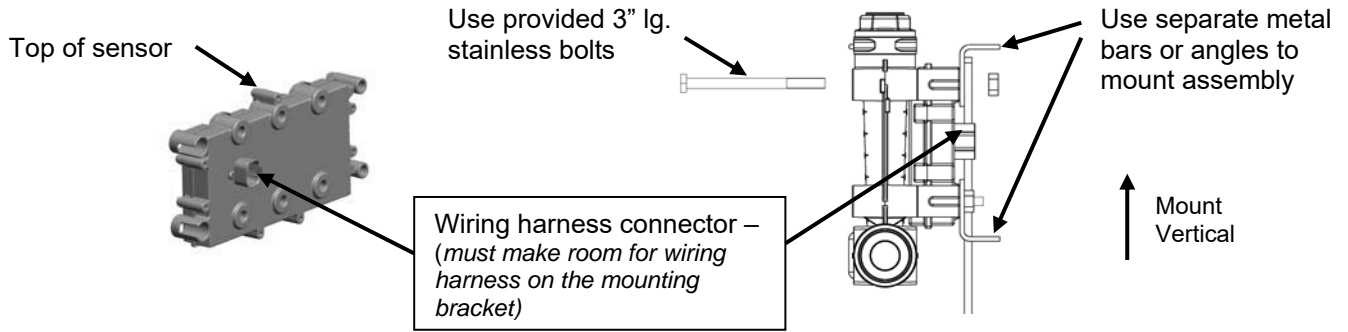

- The sensors interlock with each other, and the Visagages fit into the sensor recesses.

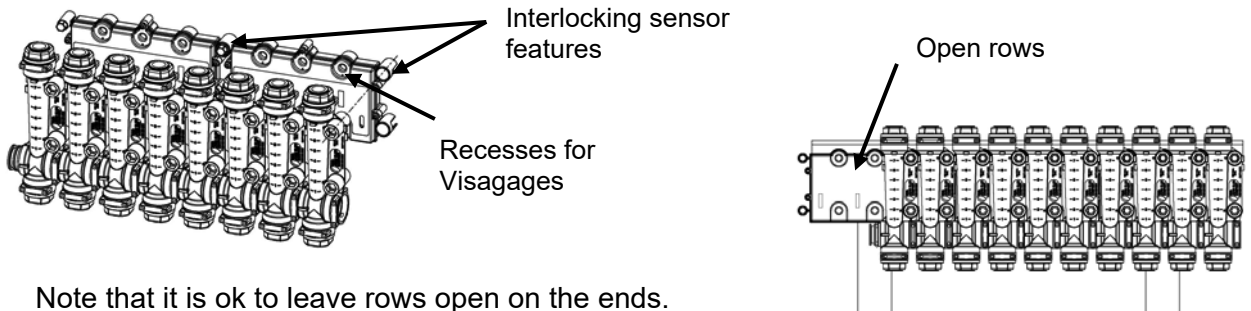

- Note that it is ok to leave rows open on the ends.

2.) Install the Magnet Balls: Use the following table to select which magnet ball is to be used in the Visagage. The magnet balls can be easily lifted out of the Visagages by using a steel screwdriver or rod to attract them. Install the balls with the “tail” up.

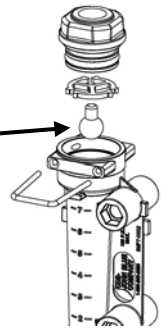

- Notes:
- a.) The maximum flow allowed through each column is 3.8 GPM (water). *An optional high flow ball (#SMPT-0079) is available to attain that flow level.*
 - b.) For solutions other than water, apply the appropriate conversion factor to the flow table values
 - c.) The balls are made from polypropylene or acetal.

FLOW RATE TABLE FOR WATER (IN GPM) (WATER = 8.34 LBS/GAL)					
LEVEL	SMPT-0060 BALL SET				SMPT-0079
	ORANGE MAGNET BALL	GRAY MAGNET BALL	YELLOW MAGNET BALL	GREEN MAGNET BALL	OPTIONAL BLUE MAGNET BALL
7	0.55	0.75	1.20	2.50	3.80
6	0.40	0.55	0.85	2.25	3.50
5	0.28	0.35	0.62	1.75	2.65
4	0.18	0.27	0.50	1.30	2.10
3	0.10	0.21	0.35	0.95	1.60
2	0.05	0.10	0.25	0.70	1.05
1	0.00	0.00	0.15	0.55	0.70

SOLUTION WEIGHT (LBS/GAL)	CONVERSION FACTOR
9.0	0.96
10.0	0.91
11.0	0.87
12.0	0.83
14.0	0.77
16.0	0.72

**** If you encounter a situation where the orange or yellow magnet ball is too heavy, you can install a non-magnet green or black ball from your Visagage set under the magnet ball to help it float higher ****

INSTALLATION (continued):

3.) Place a cow magnet in fertilizer strainer: It is recommended that a cow magnet (or similar) be placed in the fertilizer strainer to prevent metal particles from building up on the magnet balls.

4.) Mount the Control Panel: The control panel should be attached to the suction bracket stud, and then a suitable place inside the cab should be found to mount it. Note that the control panel is only intended for use in dry locations.

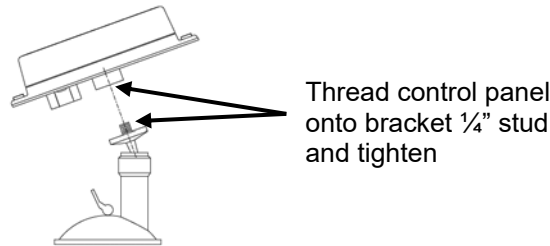

6.) Connect the Harnesses: Install them following these steps:

a.) Display Harness:

- The input power should be connected to a switched 12V DC power source in the cab that can supply 10A.
- Connect the middle connector to the control panel
- Run the end connector back toward the hitch.

b.) 28ft Extension Harness:

- Connect to the display harness and run back to the rear of the implement.

c.) Tee Harness:

- Connect to the 28ft extension

d.) 15ft Extension Harness (*in BM-08PL kit*):

- Connect to the tee harness and run toward the sensor assemblies

e.) Tee Harness at each sensor:

- Connect to the 15 ft harness, and to the neighboring sensor

f.) Terminator Plug:

- At the last sensor, place on open connector

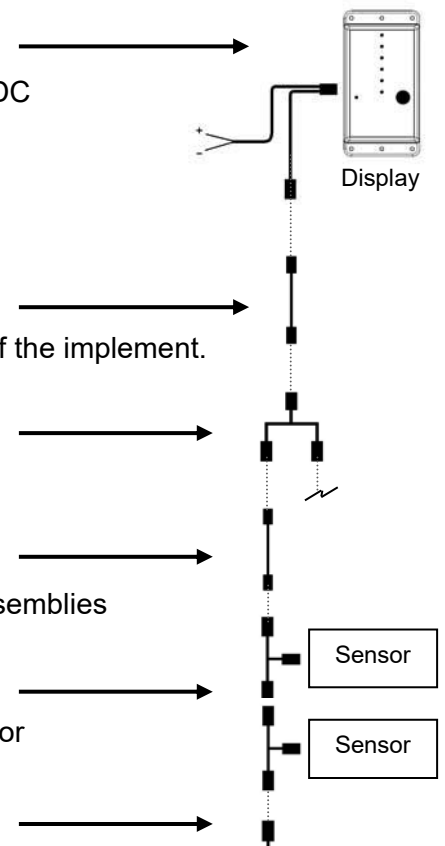

Notes:

- The harnesses can be connected in any order, and harnesses can be eliminated if needed but the terminator plug needs to be installed on the last open connector.
- Use wire ties to restrain the harnesses to the machine – take care to avoid sharp edges and pinch points when folding the machine.

- Electrical requirements:	Allowable input voltage range	8-16V DC
	Max amp draw for display	0.11 A (@12V)
	Max amp draw per sensor	0.27 A (@12V)

OPERATION

The following sections describe the components and functions of the Liquid Blockage Monitor, and instruct how to use it:

Control Panel:

- The **selection button** on the control panel has three functions:
 - o To silence the audible alarm with a single push
 - o To engage Pause Mode with a double push
 - o To change the ball level setting by pushing and holding (Repeated pushes of the button soon afterward will change the level)
- The **ball level alarm setting** LEDs indicated at which position on the Visagage flow monitor the ball must stay above.
- The **blocked row** LED will flash when a ball is sensed at or below the set level.
- It is recommended that you set your alarm setting at least 2 steps below where the ball is running the Visagages.



Sensor Assembly:

- The sensor assembly has 4 LEDs located in the slots on the lower front of the enclosure. The LEDs have the following functions:
 - o In normal operation the LEDs are solidly lit
 - o If a blockage has been sensed (or at start-up), the LEDs of the specific rows will flash.
 - o If there is an error detected, the LEDs will flash in a specific faster pattern (see Troubleshooting section).

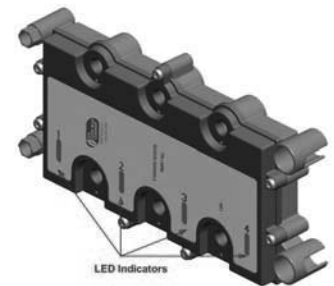

Power Up:

- When the system is first powered up, the control panel will conduct a self-test (all LEDs will illuminate and the alarm will sound), then it will show at what ball level it is set at.
- The sensor assemblies will also conduct a self-test (all LEDs will illuminate solid for a short time) and then they will start flashing (see next topic).

Prior to Pump Start:

- Before the pump has been started, the system will assume that every row is blocked and the control panel blocked row LED will be flashing.
- Note that all of the LEDs on the sensors will also be flashing, including those that may not have a Visagage installed over them.

Pump Running (first time):

- After the pump has been running a short time, the system will determine which rows do not have a Visagage (and consequently no magnetic ball) over them. At that time the LED for these empty rows will turn off to show they have been deactivated.
- For the rows that do have Visagages, the LED will change to be on solid when the ball rises above the alarm level setting.

OPERATION (continued):

Blocked Row:

- During operation if any of the balls fall below the alarm setting, the blocked row led will flash on the control panel and the alarm will sound after a short delay.
- On the sensor assemblies, the specific row(s) that caused the alarm will have a flashing LED.

Pump Stop to Investigate a Blocked Row:

- When the pump has been stopped to work on the blockage problem, the system will realize that all of the other balls have dropped at the same time (within a few seconds). The system will not report them all as blocked. Instead it will remember which ones were blocked before stopping (and keeps them flashing). The other LEDs will be on solid.
- This allows you to go back to the row units and easily identify the problem row(s).
- Afterwards when a blockage has been corrected and the pump restarted, the alarm will reset itself after the ball rises again above the level setting.

Headlands Pump Stop:

- At the end of a row when the pump is stopped, the system will note that all of the balls have dropped at the same time.
- During this time, the blocked row light will flash on the control panel but the alarm will not sound.
- The LEDs will all be on solid (provided that there were no blockages sensed at that time).

Pause Mode:

- At any time, the selection button may be double pressed to enter Pause Mode. This will hold the current state of the system indefinitely so that work may be performed on the distribution system.
- All of the LEDs on the control panel will illuminate when Pause Mode is activated.
- This is useful if the blockage is intermittent and hard to catch while stopping, especially if the balls drop too slowly. Pause Mode may be engaged while running in the field and you may stop later at a convenient time.
- To exit Pause Mode, push the selection button one time.

TROUBLE SHOOTING

ISSUE	POSSIBLE CAUSES
No LEDs are lit on control panel	Power is not turned on, or poor power/ground connections.
	4 pin connectors are not fully engaged.
	Pinched or damaged wiring – check all pinch points.
No LEDs are lit on sensor(s)	The empty row identification process may have incorrectly turned rows off - cycle system power to reset.
	4 pin connectors are not fully engaged.
	Pinched or damaged wiring – check all pinch points.
System does not remember which rows were blocked correctly after the pump has been stopped	When stopping to troubleshoot a blockage, the fluid flow must be stopped within a reasonable amount of time for this function to work correctly or the system will detect that many rows are blocked. Start the pump again and after the system is reporting blockages as it should, be sure to stop the fluid flow within 5 seconds or less.
Frequent false alarms	The alarm level setting may need to be lowered.
	If a ball is pegged to the top of a Visagage column, the signal may be lost – try lowering the level of the ball.
	There may be some rows that drop to your set alarm level for a short time and then return to normal. Set alarm to a lower level.
LEDs on control panel or sensor assemblies are flashing rapidly	There is a communication error, most likely caused by a wiring problem. Check for wiring damage and check connections, then turn power off and on.
All LEDs on control panel are on solid	The system is in Pause Mode – press the selection button one time to exit the mode.
Metal particles are sticking to magnet balls	It is recommended that a cow magnet (or similar) be placed in your strainer to catch metal particles.

PARTS LIST

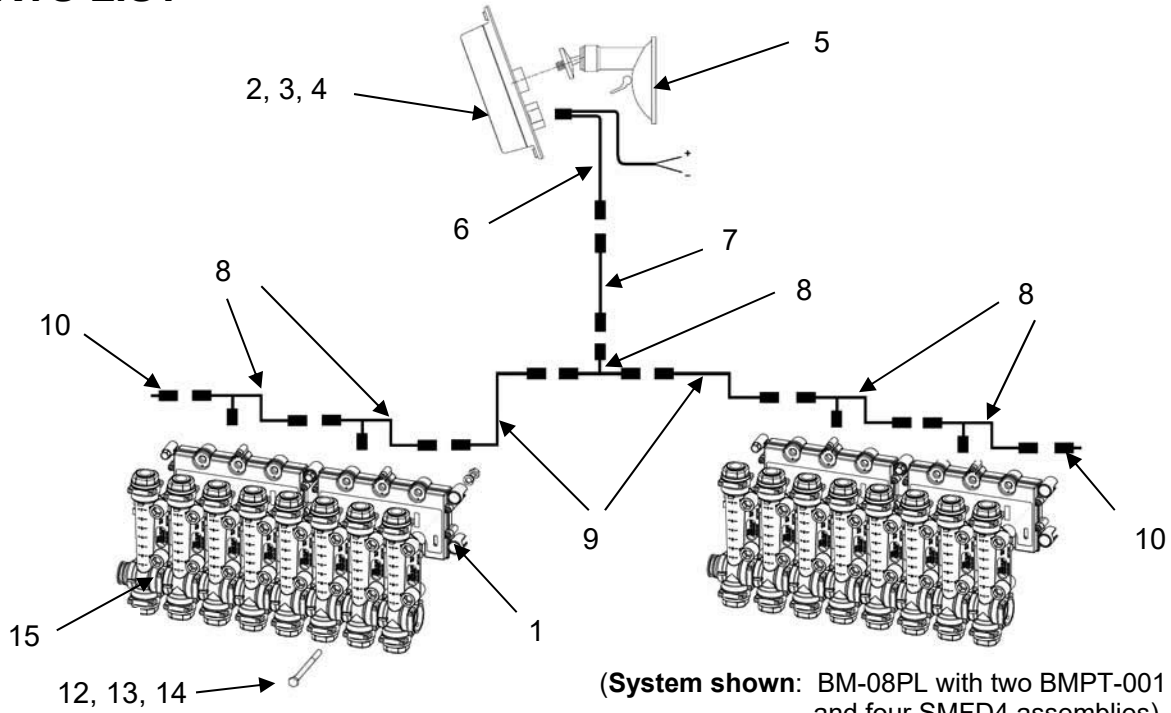

Item	Part Number	Description	Qty
1	BMPT-002	Standard sensor	(variable)
2	BMPT-009	Control panel	1
3	BMPT-017	Control panel bracket	1
4	90501	#4x1/4 screw	1
5	BMPT-020	Suction mount	1
6	BMPT-010	Input harness	1
7	BMPT-012	28ft extension harness	1
8	BMPT-011	Tee harness	(variable)
9	BMPT-013	15ft extension harness	(variable)
10	BMPT-015	Terminator plug	2
11	BMPT-014	7ft extension harness (not shown)	optional
12	BMPT-038	8 inch extension harness (not shown)	optional
13	90623	1/4"-20 x 3" long SS Hex Bolt	8 per sensor
14	93005	1/4" plated lock washer	8 per sensor
15	92015	1/4"-20 plated nut	8 per sensor
16	SMFD4	Visagage set – sold separately (FD style shown)	~
17	SMPT-0057	Orange low flow magnet ball (not shown)	4 per set (#23)
18	SMPT-0058	Yellow standard magnet ball (not shown)	4 per set (#23)
19	SMPT-0068	Green medium flow magnet ball (not shown)	4 per set (#23)
20	SMPT-0085	Grey low-medium flow magnet ball (not shown)	4 per set (#23)
21	SMPT-0079	OPTIONAL: Blue high flow magnet ball (not shown)	optional each

Kits:		
22	BMPT-001	Sensor Expansion Kit (includes items: 1, 8, 23, and eight each of 13, 14, 15)
23	SMPT-0060	Magnet ball kit for one sensor (four each of 17, 18, 19, 20)

NOTES

LIMITED WARRANTY

THIS WARRANTY IS IN LIEU OF ALL OTHER WRITTEN OR EXPRESS WARRANTIES AND REPRESENTATIONS. ANY IMPLIED WARRANTIES INCLUDING MERCHANTABILITY OR FITNESS FOR ANY PARTICULAR PURPOSE ARE EXPRESSLY LIMITED TO THIS WRITTEN WARRANTY. CDS-JOHN BLUE COMPANY SHALL NOT BE LIABLE FOR CONSEQUENTIAL DAMAGES.

Use of this product for any purpose other than its original intent, abuse of the product, and/or any modification to the original product is strictly prohibited by the manufacturer, CDS-John Blue Company. Any modification to the product should be approved by CDS-John Blue Company prior to use. CDS-John Blue Company will deny Warranty claims and liability in any situation involving misuse, abuse or modification.

Each new machine or component manufactured by CDS-John Blue Company through original buyer is warranted by CDS-John Blue Company to buyer and to any party or parties to whom buyer may resell, lease or lend the equipment to be free from defects in material and workmanship under normal use and service. This obligation of CDS-John Blue Company under this warranty is limited to the repair or replacement of defective parts or correction of improper workmanship of any parts of such equipment which shall within one year from the date of CDS-John Blue's original delivery thereof, be returned to CDS-John Blue's factory, transportation charges prepaid and which CDS-John Blue Company shall determine to its satisfaction upon examination thereof to have been thus defective. When it is impractical to return the defective parts of such equipment to CDS-John Blue's factory, then CDS-John Blue shall have no liability for the labor cost involved in repairing or replacing any such parts and shall be liable solely for supplying the material necessary to replace or repair the defective parts, provided that prior thereto CDS-John Blue Company shall have determined to its satisfaction that any such parts are thus defective.

This warranty shall not apply to any equipment which shall have been repaired or altered outside CDS-John Blue's factory in any way so as to affect its durability, nor which has been subjected to misuse, abuse, negligence or accident, or operated in any manner other than in accordance with operating instructions provided by CDS-John Blue Company. This warranty does not extend to repairs made necessary by the use of inferior or unsuitable parts or accessories, or parts or accessories not recommended by CDS-John Blue Company.

CDS-John Blue Company makes no warranties in respect to parts, accessories or components not manufactured by CDS-John Blue Company, same ordinarily being warranted separately by their respective manufacturers.

DIVISION OF ADVANCED SYSTEM TECHNOLOGIES

HUNTSVILLE AL

(256) 721-9090



CDS-John Blue Company

Division of Advanced Systems Technology

165 Electronics Blvd, Huntsville, AL 35824

Telephone: (256) 721-9090 - FAX: (256) 721-9091

Toll Free: 1-800-253-2583

www.cds-johnblue.com

YOUR LOCAL DEALER

