

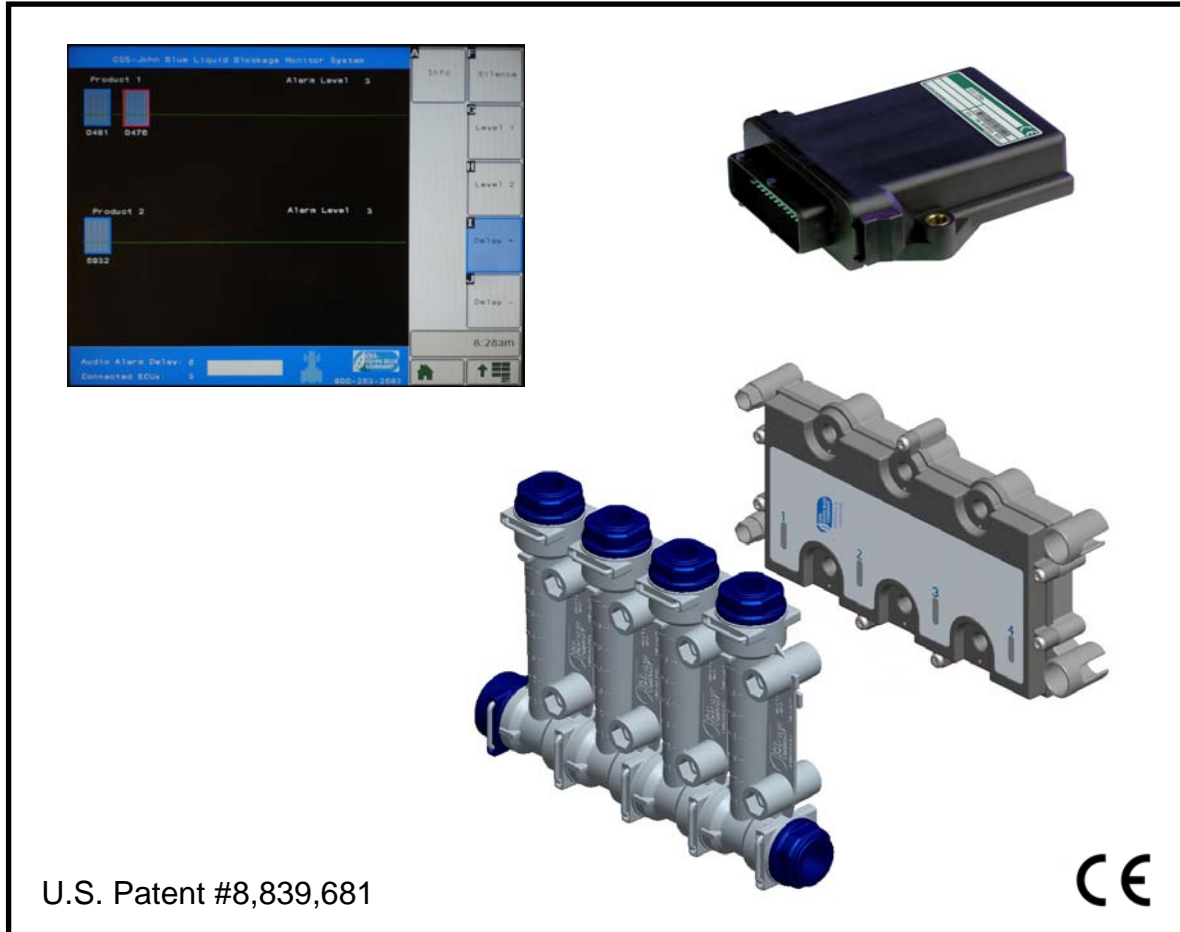

BM-08ISO-xx ISOBUS LIQUID BLOCKAGE MONITOR SYSTEM

PARTS AND INSTALLATION MANUAL



U.S. Patent #8,839,681



CDS-JOHN BLUE COMPANY

DIVISION OF ADVANCED SYSTEMS TECHNOLOGY, INC.

165 Electronics Blvd, Huntsville, AL 35824

Telephone: (256) 721-9090 - FAX: (256) 721-9091

Toll Free: 1-800-253-2583

TABLE OF CONTENTS

Safety Precautions	2
System Description	3
How to Order	4
Installation	5
Operation	8
Troubleshooting	11
Parts List	12
Device Notes	13
Conversion Kit Specific Instructions.....	13
Warranty	14

SAFETY PRECAUTIONS

- Equipment should be operated only by responsible people.
- A careful operator is the best insurance against an accident.

WARNING: USE OF THIS PRODUCT FOR ANY PURPOSES OTHER THAN ITS ORIGINAL INTENT, ABUSE OF THE PRODUCT, AND/OR MODIFICATION TO THE ORIGINAL PRODUCT IS STRICTLY PROHIBITED BY CDS-JOHN BLUE COMPANY. CDS-JOHN BLUE COMPANY RESERVES THE RIGHT TO DENY WARRANTY OR LIABILITY CLAIMS IN ANY/ALL SITUATIONS INVOLVING MISUSE, ABUSE OR MODIFICATION.

THE ORIGINAL INTENT OF THIS PRODUCT DOES NOT INCLUDE USE WHERE THE MAXIMUM ALLOWED SPEED, PRESSURE, OR TEMPERATURE IS EXCEEDED, AND IT DOES NOT INCLUDE APPLICATIONS UTILIZING FLUIDS THAT ARE NOT COMPATIBLE WITH THE PRODUCT'S COMPONENT MATERIALS. DO NOT USE THIS PRODUCT WITH FLAMMABLE OR COMBUSTIBLE FLUIDS SUCH AS GASOLINE, KEROSENE, DIESEL, ETC..., AND DO NOT USE IN EXPLOSIVE ATMOSPHERES. FAILURE TO FOLLOW THIS NOTICE MAY RESULT IN SERIOUS INJURY AND/OR PROPERTY DAMAGE AND WILL VOID THE PRODUCT WARRANTY. IF IN DOUBT ABOUT YOUR APPLICATION, CONTACT YOUR STOCKING DEALER OR THE CDS-JOHN BLUE TECHNICAL STAFF AT 1-800-253-2583.

**** Note:** John Deere and Greenstar names and logos are property of Deere & Company, Moline IL.

To The Owner

This manual has been prepared and illustrated to assist you in the maintenance of your CDS – JOHN BLUE product. Enter your serial number and the date of the purchase in the space provided below for future reference in service information or for ordering parts. Because our engineering department is constantly improving products, we reserve the right to make design and specification changes without notice.

Model Number: _____ Serial Number: _____ Purchase Date: _____

SYSTEM DESCRIPTION

The CDS-John Blue ISOBUS Liquid Blockage Monitor System is an automatic warning system that lets the operator know when the ball (and flow) in an individual row has dropped below a selected level in a CDS-John Blue Visagage II flow monitor. The system also gives real-time ball level updates for each row as it is running using a properly equipped ISOBUS compatible VT (virtual terminal) display.

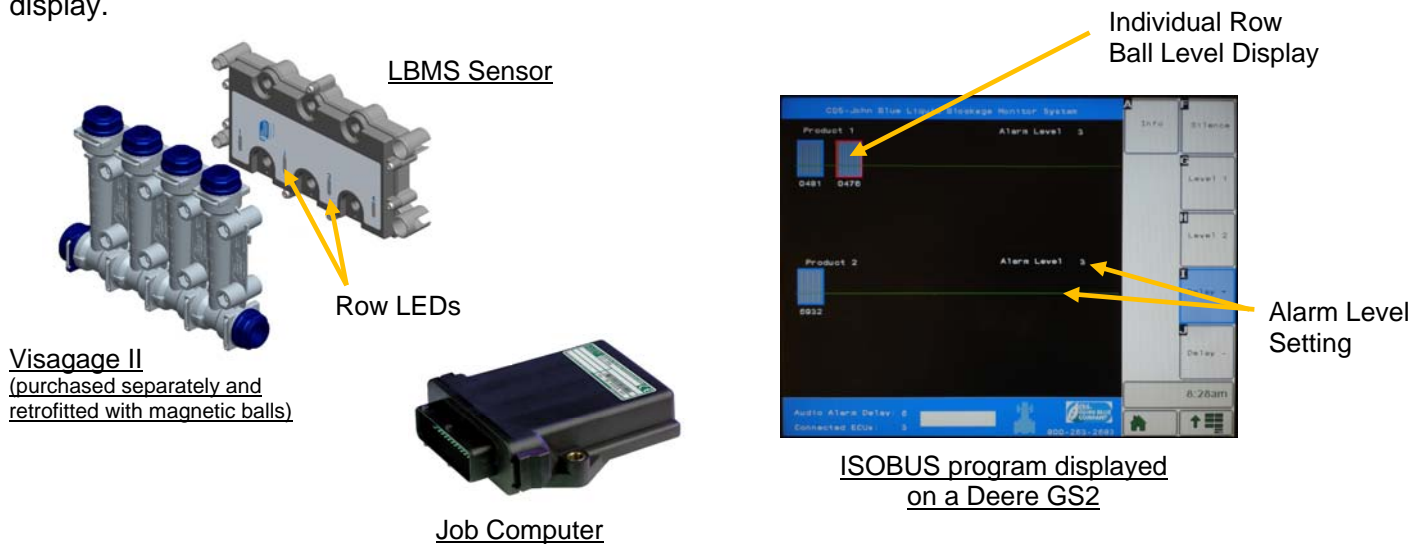

This system uses sensor assemblies mounted behind the Visagage flow monitors to sense where magnetic balls are floating in each row during liquid application. The sensors communicate with the VT display in the cab through the factory CAN system using the supplied job computer. The VT allows the user to select at which level on the Visagage the alarm will sound when a ball drops to or below that level. ** Note that your VT may require a software download from your dealer to run ISOBUS programs – check with them to verify. **

When a low ball position has been detected, visual and audible alarms will alert the user. Additionally, each row that had a low ball will be highlighted by a flashing LED located in the sensor assemblies behind the Visagage columns to help with troubleshooting the blockages. When the blockage has been corrected and the ball again goes above the alarm level, the alarm will reset automatically.

The base system is sold with enough components to monitor an 8-row system. To size it for larger machines, 4-row Sensor Expansion Kits (part #BMPT-001) are added as needed. Note that while the sensor assemblies are sized to monitor 4-rows at a time, it is ok to leave rows empty if the machine has an odd number of rows. The harness lengths are sized for normal size machines, but if longer lengths are needed extension cables are available - measure the machine first.

HOW TO ORDER

Step 1: Purchase an ISOBUS 8 Row Liquid Blockage Monitor Kit, #BM-08ISO(-xx):

Components Included in BM-08ISO, BM-08ISO-JD, etc.:

- A. Main Computer Harness
- B. Job Computer
- C. Tap Harness (universal or brand-specific (i.e. Deere))
- D. Tee Harness
- E. 15ft Extension harness (qty = 2)
- F. Standard Sensor Kit (qty = 2)
(includes standard sensor, tee harness, 12 magnet balls, & hardware)
- G. Terminator Plug (qty =2)

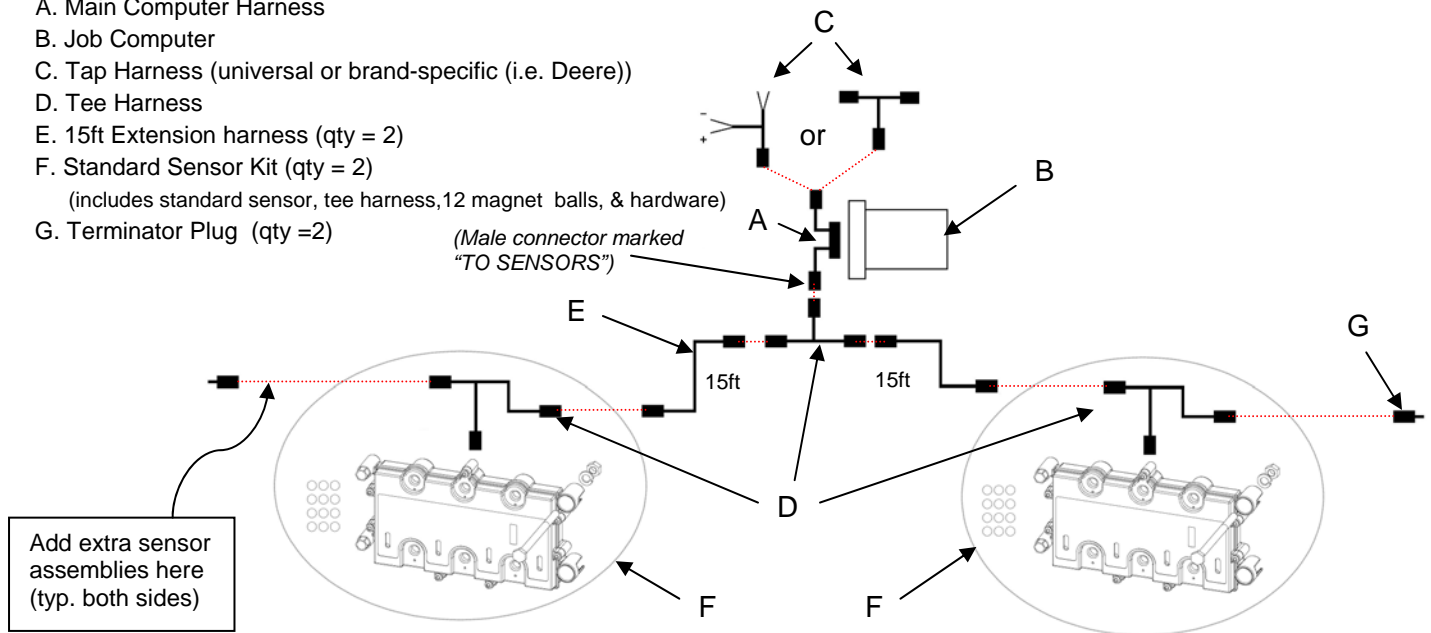

Step 2: If the harness lengths supplied are not long enough for your machine measurements, you can order more of these harnesses and add them anywhere in the circuit:

BMPT-012	28FT Extension harness
BMPT-013	15FT Extension harness
BMPT-014	7FT Extension harness

Step 3: Purchase the required number of 4-Row Sensor Expansion Kits (#BMPT-001) to cover the number of rows on your machine (extra rows are ok). The location of the individual sensors does not matter, and they do not have to be evenly split.

Step 4: Order the required number of Visagage II assemblies for your machine, and at installation you will replace the standard balls with the appropriate magnet ball for your specific row flow rate (see page 6).

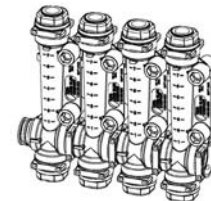

Step 5: Verify that your virtual terminal has the correct software in order to run ISOBUS programs.

INSTALLATION

1.) Mounting the Liquid Blockage Monitor Sensors: The sensors mount behind the Visagage II columns using the provided hardware. The assembly must be mounted vertically as shown, and lengthwise it should be horizontal. Clearance must be given around the wiring connector on the back of the sensor, so a good choice for mounting bracket material would be two strips of angle or bar.

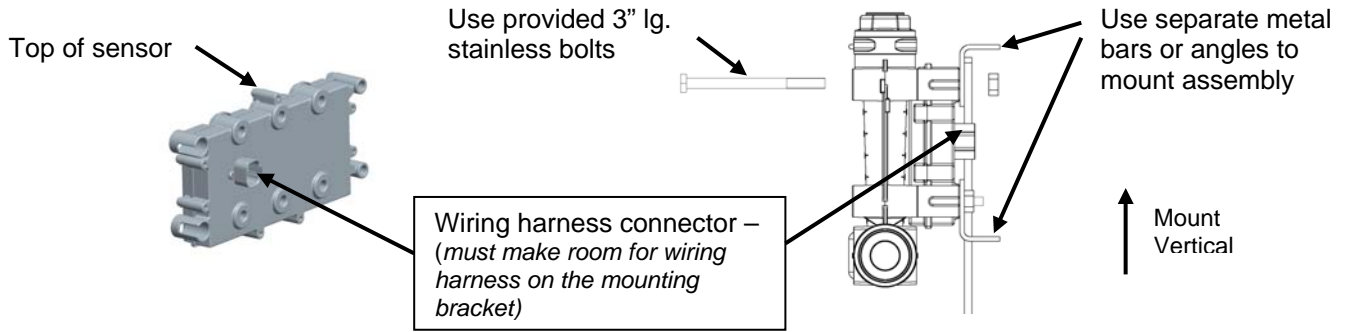

- The sensors interlock with each other, and the Visagages fit into the sensor recesses.

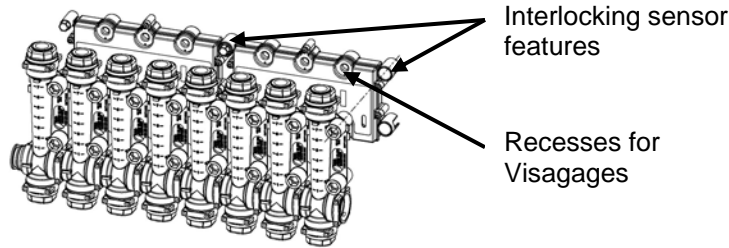

- Note that it is ok to leave rows open on the ends.

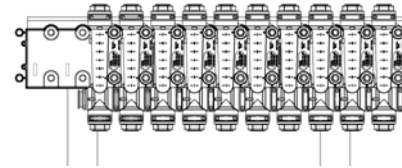

- If you are applying two separate products, all of the sensors still connect to each other with only one wireless sensor in the system. If the Visagages are spaced apart you will need purchase an extension harness – see page 4. Note that currently a **maximum of 56 rows** may be displayed on each line.

- Be sure to write down the **serial numbers** of the sensors from left to right as you sit in the tractor - it will help you when placing the sensors in the Blockage Monitor program on the display:

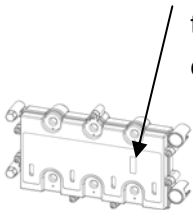

_____	_____	_____	_____	_____	_____	_____
_____	_____	_____	_____	_____	_____	_____
_____	_____	_____	_____	_____	_____	_____
_____	_____	_____	_____	_____	_____	_____

INSTALLATION (continued):

2.) Install the Magnet Balls: Use the following table to select which magnet ball is to be used. Note that if needed the magnet balls can be easily lifted out of the Visagages by using a steel screwdriver or rod to attract them. Install the balls with the “tail” up.

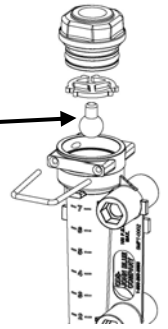

- Notes:
- a.) The maximum flow allowed through each column is 3.8 GPM (water). An optional high flow ball (#SMPT-0079) is available to attain that flow level.
 - b.) For solutions other than water, apply the appropriate conversion factor to the flow table values
 - c.) The balls are made from polypropylene or acetal with stainless steel weights.

FLOW RATE TABLE FOR WATER (IN GPM) (WATER = 8.34 LBS/GAL)					
LEVEL	SMPT-0060 BALL SET			SMPT-0085	SMPT-0079
	ORANGE MAGNET BALL	YELLOW MAGNET BALL	GREEN MAGNET BALL	OPTIONAL GRAY MAGNET BALL	OPTIONAL BLUE MAGNET BALL
7	0.55	1.20	2.50	0.75	3.80
6	0.40	0.85	2.25	0.55	3.50
5	0.28	0.62	1.75	0.35	2.65
4	0.18	0.50	1.30	0.27	2.10
3	0.10	0.35	0.95	0.21	1.60
2	0.05	0.25	0.70	0.10	1.05
1	0.00	0.15	0.55	0.00	0.70

SOLUTION WEIGHT (LBS/GAL)	CONVERSION FACTOR
9.0	0.96
10.0	0.91
11.0	0.87
12.0	0.83
14.0	0.77
16.0	0.72

**** If you encounter a situation where the orange or yellow magnet ball is too heavy, you can install a non-magnet green or black ball from your Visagage set under the magnet ball to help it float higher. Also note that an optional gray ball is available with flow values between the orange and yellow balls. ****

3.) Place a cow magnet in fertilizer strainer: It is recommended that a cow magnet (or similar) be placed in the fertilizer strainer to prevent metal particles from building up on the magnet balls.

4.) Connect the Harnesses:

a.) Universal Input Harness – BM-08ISO:

- Red wire = 12v+, to pin 4 of ISOBUS 11783 connector or another 12v source
- Black wire = GND, to pin 2 of ISOBUS connector or another ground
- Yellow wire = CAN-H, to pin 8 of ISOBUS connector (splice into circuit)
- Green wire = CAN-L, to pin 9 of ISOBUS connector (splice into circuit)

- or -

Deere Splice Harness – BM-08ISO-JD:

Connect the harness between the two black 12 pin Amp connectors
(On 1770 planters – it is visible as you climb the rear stairs)

b.) Main Computer Harness

- Connect to the input harness and computer

c.) 15ft Extension Harnesses and Tee

- Connect to the input harness and run toward the sensor assemblies on the far side of the implement.

d.) Tee Harness at each sensor:

- Connect to the preceding harness, and to the neighboring sensor.

e.) Terminator Plug:

- At the last sensor, place on open connector.

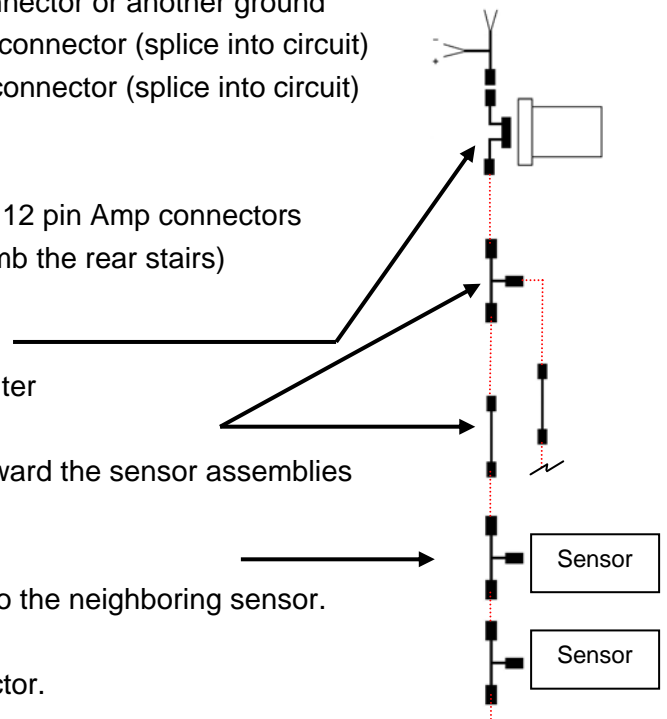

INSTALLATION (continued):

5.) Mount the Job Computer: Using the computer case holes, rigidly mount the computer. The hole is sized for use with 1/4" diameter bolts, and the hole spacing is 4.0".



6.) Setup the LBMS program:

Open the Blockage Monitor program and you will see the sensors that are connected to the "network".

There are a few items that need to be configured before you start using the system:

1.) The sensors can be **arranged in order** from left to right by selecting the **serial number** of each sensor, which will open the "ECU Configuration" screen. You may change the order by selecting "**Index +**" and then "**Save**" to exit. You may also abort changes by selecting "**Cancel**".

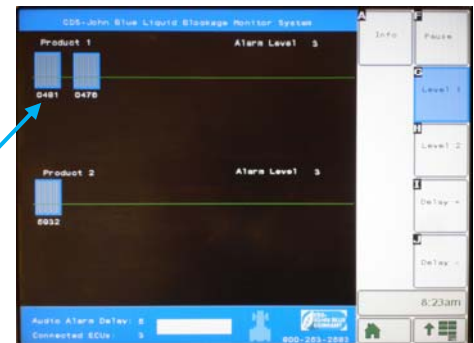

2.) If you are running **more than one product**, you may change which product a sensor is assigned to in this screen by selecting the "**Prod +**" button. Again, select save when exiting to retain the change.

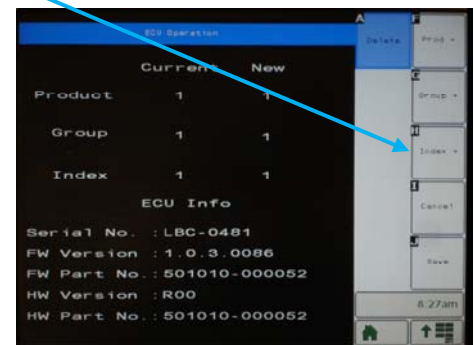

3.) If you have section control on your machine, you may **define sensors as being in certain sections** while in this screen by selecting "**Group +**" to change the ecu's group number. This will keep the system from activating the blockage alarm when a whole section (or sections) have been shut off. A maximum of 8 sections may be defined.

OPERATION

The following sections describe the components and functions of the Liquid Blockage Monitor:

Program Controls:

- The program allows you adjust the following system functions:
 - o Adjust ball level where the alarm will sound
 - o Silence the alarm when a blockage happens
 - o Set two different product types and define sections
 - o See the system information
 - o Pause the system to hold the current state
 - o Set delay before the audible alarm will sound

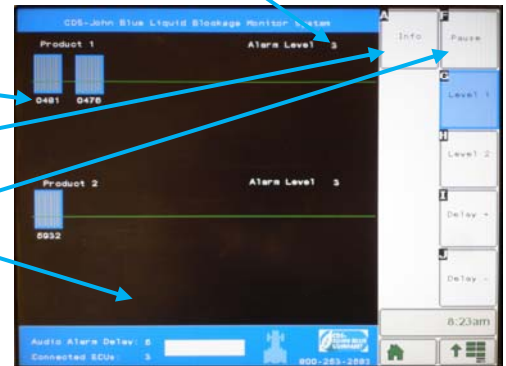

- The **ball level alarm setting** indicates the position on the Visagage flow monitor the ball must stay above. The **visual and audible alarms** will occur when a ball is sensed at or below the set level. It is recommended that you set your alarm setting at least 2 steps below where the ball is running the Visagages.
- The program is able to **run in the background** of the VT, and will sound the audible alarm if the volume is turned up.

Sensor Assembly:

- The sensor assembly has 4 LEDs located in the slots on the lower front of the enclosure. The LEDs have the following functions:
 - o In normal operation (with fluid flow) the LEDs are solidly lit
 - o Note that at start-up, they may flash **before** flow starts or they may turn off before flow.
 - o If a blockage has been sensed during operation, the LED will flash.
 - o If there is an error detected, the LEDs will flash in a specific pattern (see Troubleshooting section)

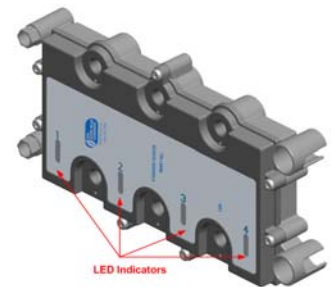

OPERATION (continued):

Power Up:

- When the system is first powered up, the sensor assemblies will conduct a self-test (all LEDs will illuminate solid for a short time) and then they will start flashing (see next topic).

Prior to Pump Start:

- Before the pump starts running, the system will assume that every row is blocked and all of the LEDs on the sensors will be flashing - including those that may not have a Visagage installed over them. It is also possible that all LEDs will turn off as the ISOBUS program is being loaded.

Pump Running (first time):

- After the pump has been running a short time, the system will determine which rows do not have a Visagage (and consequently no magnetic ball) over them. At that time the LED for these empty rows will turn off to show they have been deactivated.
- For the rows that do have Visagages, the LED will change to be on solid when the ball rises above the alarm level setting.

Blocked Row:

- During operation if any of the balls fall below the alarm setting, the blocked row alarm will sound.
- You may silence the alarm with the "Silence" button on the screen.
- On the sensors, the specific row(s) that caused the alarm will have a flashing LED.

Pump Stop to Investigate a Blocked Row:

- When the pump has been stopped to work on the blockage problem, the system will realize that all of the other balls have dropped at the same time (within a few seconds).
- The system will not report them all as blocked. Instead it will remember which ones were blocked before stopping (and keeps them flashing on the sensors). The other LEDs will be on solid.
- This allows you to go back to the row units and easily identify the problem row(s).
- Afterwards when a blockage has been corrected and the pump restarted, the alarm will reset itself after the ball rises again above the level setting.

Headlands Pump Stop:

- At the end of a row when the pump is stopped, the system will note that all of the balls have dropped at the same time and will not sound the alarm.
- The LEDs will all be on solid (provided that there were no blockages sensed at that time).

OPERATION (continued):

Pause Mode:

- At any time, the “PAUSE” button may be pressed to enter Pause Mode. This will hold the current state of the system indefinitely so that work may be performed on the distribution system.
- This is useful if the blockage is intermittent and hard to catch while stopping, especially if the balls drop too slowly.
- Pause Mode may be engaged while running in the field so that you may stop later at a convenient time to troubleshoot the line problem.
- To exit Pause Mode, push the “RESUME” button (in same location).

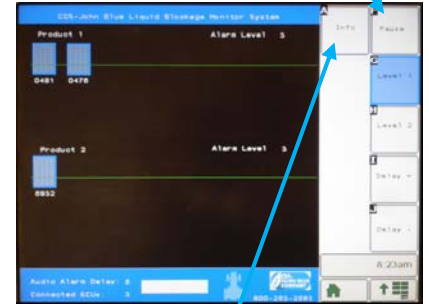

Sensor Calibration:

- If the reported ball levels do not appear to be correct, or if when the balls are at the bottom (after pump flow shutoff) but the display reports them to be up, a recalibration should be executed. Recalibration sets the “zero” point for each of the sensors used to detect ball position on each row.
- Choose the “INFO” button on the screen. Then choose “Cali” button.
- You **must remove the magnetic balls** from the Visagages before choosing “Start” on the final screen. Failure to do this will affect system operation and you will have to repeat the process correctly.

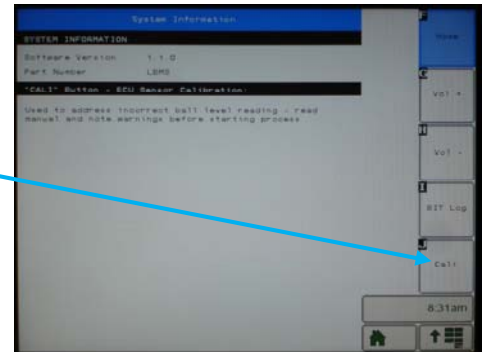

TROUBLE SHOOTING

ISSUE	POSSIBLE CAUSES
No LEDs are lit on sensor(s) or power loss is experienced	If you are sharing power connections with 12v pumps or air compressors, they may pull the voltage down at start-up momentarily and affect the LBMS system.
	4 pin connectors are not fully engaged.
	Pinched or damaged wiring – check all pinch points.
	Bad ground or power connections.
System does not remember which rows were blocked correctly after the pump has been stopped	The fluid flow must be stopped quickly this function to work correctly or the system will detect that many rows are blocked. Start the pump again and then stop the fluid flow within 5 seconds or less.
	Alternatively, use the “Pause” feature to capture blocked rows before stopping.
Frequent false alarms	The alarm level setting may need to be set lower, or you may need to set the alarm delay to a higher number.
	If a ball is pegged to the top of a Visagage column, the signal may be lost – try lowering the level by changing to another ball or ball combination.
	If a ball is not moving off of the bottom , the system may not turn on the row. Change to another ball or use a light non-magnet ball to lift the orange or yellow ball.
LEDs on sensor assemblies are flashing rapidly (after waiting for VT to power up and starting the LBMS program)	There is a communication error, most likely caused by a wiring problem between sensors. Check for wiring damage and check connections, then turn system power off and on.
Zero ECUs connected, or some sensors missing	Ensure that all connectors are fully engaged.
	Ensure that the terminator plugs are installed.
System inaccuracy problems	If the reported ball levels do not appear to be correct, or if when the balls are at the bottom but the display reports them to be up, a recalibration should be executed. See page 10.
Metal particles are sticking to magnet balls	It is recommended that strong cow magnets (non-cage style) be placed in your strainer to catch metal particles.

PARTS LIST

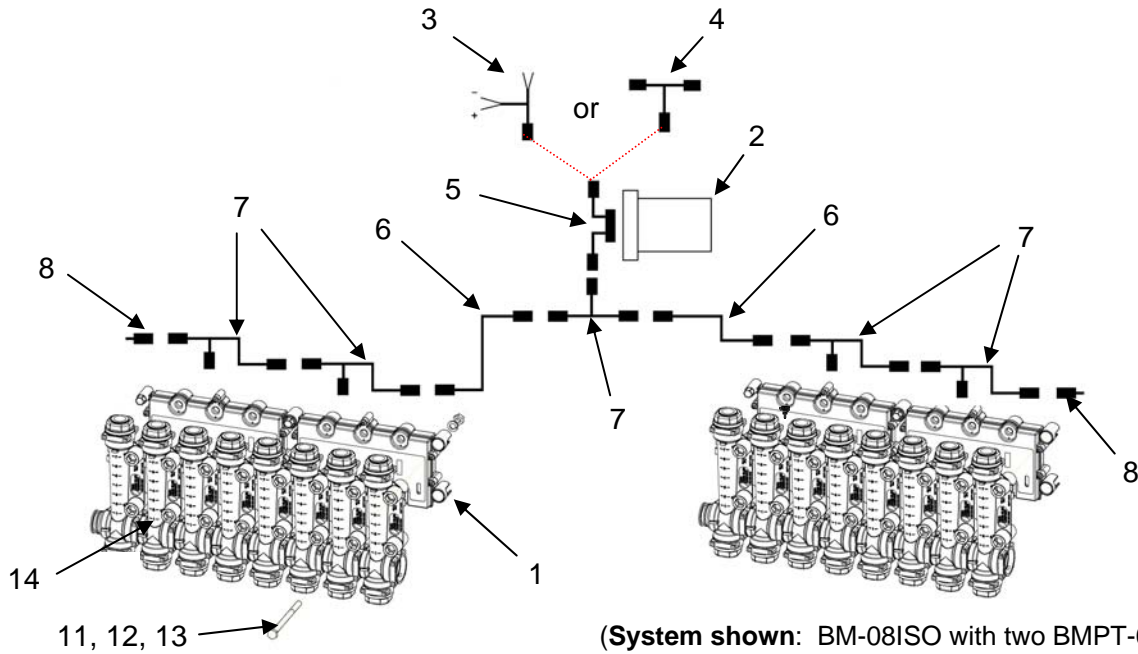

Item	Part Number	Description	Qty
1	BMPT-002	Standard sensor	(variable)
2	BMPT-030	Job computer	1
3	BMPT-034	Universal input harness	1
4	BMPT-032	Deere CANbus tap harness	2
5	BMPT-031	Computer harness	1
6	BMPT-012	15ft extension harness	1
7	BMPT-011	Tee harness	(variable)
8	BMPT-015	Terminator plug	2
9	BMPT-012	28ft extension harness (not shown)	optional
10	BMPT-014	7ft extension harness (not shown)	optional
11	90623	¼"-20 x 3" long SS Hex Bolt	8 per sensor
12	93005	¼" plated lock washer	8 per sensor
13	92015	¼"-20 plated nut	8 per sensor
14	SMFD4	Visagage set – sold separately (FD style shown)	~
15	SMPT-0057	Orange low flow magnet ball (not shown)	4 per set (#21)
16	SMPT-0058	Yellow standard magnet ball (not shown)	4 per set (#21)
17	SMPT-0068	Green medium flow magnet ball (not shown)	4 per set (#21)
18	SMPT-0079	OPTIONAL: Blue high flow magnet ball (not shown)	optional each
19	SMPT-0085	OPTIONAL: Grey magnet ball (not shown)	optional each

Kits:		
20	BMPT-001	Sensor Expansion Kit (includes items: 1, 7, 21, and eight each of 11, 12, 13)
21	SMPT-0060	12 Magnet ball kit for one sensor (four each of 15, 16, 17)
	BMPT-036	Universal ISOBUS conversion kit for BMi-08 (tablet version)
	BMPT-036-JD	Deere ISOBUS conversion kit for BMi-08 (tablet version)
	BMPT-037	Universal ISOBUS conversion kit for BM-08PL & AP (std version)
	BMPT-036-JD	Deere ISOBUS conversion kit for BM-08PL & AP (std version)

DEVICE NOTES

Electrical requirements:	Allowable system input voltage range	8-16 V DC
	Max amp draw job computer	0.10 A (@12V)
	Max amp draw for each standard sensor	0.27 A (@12V)

Changes or modifications not expressly approved by the party responsible for compliance could void the user's authority to operate the equipment.

CONVERSION KIT SPECIFIC INSTRUCTIONS

BMPT-036-xx:

This kit is intended for customers that have the tablet version (BMi-08) of the LBMS. You must replace the wifi sensor (BMPT-003) with the included standard sensor (BMPT-002) for it to work properly.

You will need to remove and discard the input harness that was supplied with the original kit, and install the tee harness and 15ft harness in its place. The job computer should be installed near this tee harness that splits the sensors from left to right. See the installation instructions on pages 4 thru 7 in this manual for more details.

BMPT-037-xx:

This kit is intended for customers that have the standard version (BM-08PL and BM-08AP) of the LBMS. No changes are necessary with regard to the sensors.

You will need to remove and discard: the standard control panel, the input harness used in the cab, and the long wire that was run to the cab of the tractor. The job computer should be installed near the tee harness that splits the sensors from left to right using the supplied harnesses. See the installation instructions on pages 4 thru 7 in this manual for more details.

LIMITED WARRANTY

THIS WARRANTY IS IN LIEU OF ALL OTHER WRITTEN OR EXPRESS WARRANTIES AND REPRESENTATIONS. ANY IMPLIED WARRANTIES INCLUDING MERCHANTABILITY OR FITNESS FOR ANY PARTICULAR PURPOSE ARE EXPRESSLY LIMITED TO THIS WRITTEN WARRANTY. CDS-JOHN BLUE COMPANY SHALL NOT BE LIABLE FOR CONSEQUENTIAL DAMAGES.

Use of this product for any purpose other than its original intent, abuse of the product, and/or any modification to the original product is strictly prohibited by the manufacturer, CDS-John Blue Company. Any modification to the product should be approved by CDS-John Blue Company prior to use. CDS-John Blue Company will deny Warranty claims and liability in any situation involving misuse, abuse or modification.

Each new machine or component manufactured by CDS-John Blue Company through original buyer is warranted by CDS-John Blue Company to buyer and to any party or parties to whom buyer may resell, lease or lend the equipment to be free from defects in material and workmanship under normal use and service. This obligation of CDS-John Blue Company under this warranty is limited to the repair or replacement of defective parts or correction of improper workmanship of any parts of such equipment which shall within one year from the date of CDS-John Blue's original delivery thereof, be returned to CDS-John Blue's factory, transportation charges prepaid and which CDS-John Blue Company shall determine to its satisfaction upon examination thereof to have been thus defective. When it is impractical to return the defective parts of such equipment to CDS-John Blue's factory, then CDS-John Blue shall have no liability for the labor cost involved in repairing or replacing any such parts and shall be liable solely for supplying the material necessary to replace or repair the defective parts, provided that prior thereto CDS-John Blue Company shall have determined to its satisfaction that any such parts are thus defective.

This warranty shall not apply to any equipment which shall have been repaired or altered outside CDS-John Blue's factory in any way so as to affect its durability, nor which has been subjected to misuse, abuse, negligence or accident, or operated in any manner other than in accordance with operating instructions provided by CDS-John Blue Company. This warranty does not extend to repairs made necessary by the use of inferior or unsuitable parts or accessories, or parts or accessories not recommended by CDS-John Blue Company.

CDS-John Blue Company makes no warranties in respect to parts, accessories or components not manufactured by CDS-John Blue Company, same ordinarily being warranted separately by their respective manufacturers.

DIVISION OF ADVANCED SYSTEM TECHNOLOGIES

HUNTSVILLE AL

(256) 721-9090



CDS-John Blue Company

Division of Advanced Systems Technology

165 Electronics Blvd, Huntsville, AL 35824

Telephone: (256) 721-9090 - FAX: (256) 721-9091

Toll Free: 1-800-253-2583

www.cds-johnblue.com

YOUR LOCAL DEALER

